

SERVICE MANUAL

SOLID-STATE STEREOPHONIC AMPLIFIER

AU-777

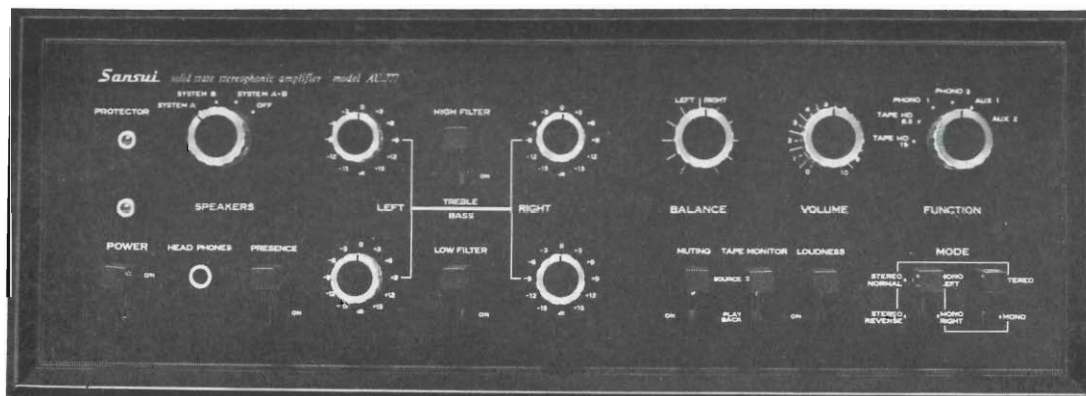

Sansui®

SANSUI ELECTRIC COMPANY LIMITED

SANSUI

SOLID STATE

STEREOPHONIC

PRE-MAIN AMPLIFIER

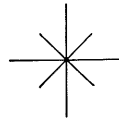

AU-777

HOW TO USE THIS SERVICE MANUAL

1. Look up the type of trouble you are confronted with in either the General or Amplifier Troubleshooting charts provided in this manual.
2. By referring to the charts, isolate the trouble to a particular unit or part. (See the column titled "What To Do" in the General chart and "Check Point" in the Amplifier Troubleshooting chart).
3. Locate the section of the chassis in which the part is located by using the co-ordinates (Column D) in the Parts List pp. 21-25.
4. Using the co-ordinates given in the Parts List (Column C), pinpoint the position of the part in the Schematic Diagram pp. 13-14

NOTE: Much of the information contained in this manual has been prepared for use by qualified service repairmen. Please read your Warranty thoroughly before attempting any internal adjustments on your own.

CONTENTS

GENERAL SECTION	3, 4
AMPLIFIER TROUBLESHOOTING CHART	
OVER ALL PROGRAM SOURCES	5, 6, 7
FOR USE WITH A RECORD PLAYER	
(MAGNETIC) OR A TAPE DECK	7, 8
OTHER PROGRAM SOURCES	9
REMOVING THE FRONT PANEL, BONNET AND	
BOTTOM PLATE	9
PRINTED CIRCUIT SHEETS	10, 11, 12
SCHEMATIC DIAGRAM	13, 14
SELECTOR CHART	15, 16
ALIGNMENT	17, 18
PARTS LAYOUT	19
BLOCK DIAGRAM	20
PARTS LIST	21, 22, 23, 24, 25
COLOR CODE	26

GENERAL SECTION

If the amplifier is otherwise operating satisfactorily, the more common causes of trouble may generally be attributed to the following:

1. Incorrect connections or loose terminal contacts. Check the speakers, record player, tape recorder, antenna and line cord.
2. Improper operation. Before operating any audio component, be sure to read the manufacturer's instruc-

tions

3. Improper location of audio components. The proper positioning of components, such as speakers and turntable, is vital to stereo.

4. Defective audio components.

The following are some other common causes of malfunction and what to do about them.

PROGRAM SOURCE	SYMPTOM	PROBABLE CAUSE	WHAT TO DO
Tuner	Constant or intermittent noise heard at certain times or in a certain area	<ul style="list-style-type: none"> * Discharge or oscillation caused by electrical appliances, such as fluorescent lamp, TV set, D.C. motor, rectifier and oscillator * Natural phenomena, such as atmospheric conditions, static, stray and thunderbolts * Insufficient antenna input due to reinforced concrete walls or long distance from the station * Wave interference from other electrical appliances 	<ul style="list-style-type: none"> * Attach a noise limiter to the electrical appliance that causes the noise, or attach it to the power source of the amplifier. * Install an outdoor antenna and ground the amplifier to raise the signal-to-noise ratio. * Reverse the power cord plug-receptacle connections. * If the noise occurs at a certain frequency, attach a wave trap to the ANT. input. * Keep the set at a proper distance from other electrical appliances.
	Noise heard at a particular time of the day, in a certain area or over part of the dial during AM reception	<ul style="list-style-type: none"> * This results from the nature of AM broadcast 	<ul style="list-style-type: none"> * Install the antenna for maximum antenna efficiency. * In some cases, the noise can be eliminated by grounding the amplifier or reversing the power cord plug-receptacle connections.
	High-frequency noise during AM reception	<ul style="list-style-type: none"> * Adjacent-channel interference or beat interference * TV set too close to the audio system 	<ul style="list-style-type: none"> * Although such noise cannot be eliminated by the amplifier, it is advisable to set the TREBLE control to the minimum counterclockwise position possible and switch on the HIGH FILTER. * Keep the TV set at a proper distance from the audio system.
	Noise during FM reception	<ul style="list-style-type: none"> * Poor noise limiter effect or too low S/N ratio due to insufficient antenna input <p>Note: FM reception is affected considerably by the broadcasting station's power and antenna efficiency. As a result, you may receive one station quite well while having difficulty in receiving another station.</p>	<ul style="list-style-type: none"> * Install the antenna for maximum signal strength. * If this does not prove effective, use an outdoor antenna designed exclusively for FM. When you use a TV antenna for both TV and FM with the help of a divider, make sure the TV reception is not affected. * An excessive long antenna may cause noise.
	"Scratching noise" heard during FM reception	<ul style="list-style-type: none"> * Ignition noise caused by an auto, motorcycle or the like 	<ul style="list-style-type: none"> * Keep the antenna and its lead-in wire away from heavy traveled roads or raise the antenna input.

PROGRAM SOURCE	SYMPTOM	PROBABLE CAUSE	WHAT TO DO
(continued)	Noise heard during FM stereo, but not heard during FM mono reception	<ul style="list-style-type: none"> * The service area of the FM stereo broadcast is only half that of the FM mono broadcast 	<ul style="list-style-type: none"> * Install the antenna for maximum antenna input. * Switch on the HIGH FILTER and/or set the TREBLE control to the minimum counterclockwise position possible.
Record player, tape recorder or tape deck	Hum or howling	<ul style="list-style-type: none"> * Record player placed directly on the speaker box * Use of wire other than shielded wire * Loose terminal contact * Shielded wire too close to the line cord, fluorescent lamp or other electrical appliances * Nearby amateur radio station or TV transmission antenna 	<ul style="list-style-type: none"> * Put a cushion under the record player. * Experiment with several different arrangements before deciding on the final positions of the speaker and record player. * Use a shielded cord for connections. * Switch on the LOW FILTER. * The connecting cord should be as short as possible. * Don't raise the BASS loudness too much * Consult the nearest Radio Regulatory Bureau.
	Surface noise	<ul style="list-style-type: none"> * Worn or old record * Worn pick-up needle * Needle covered with dust * Improper needle pressure 	<ul style="list-style-type: none"> * Set the TREBLE control to the minimum counterclockwise position possible and/or switch on the HIGH FILTER. * Clean or replace the needle.
Common to all program sources	The BALANCE control is not in the mid-position when equal sound comes from both left and right channels.	<ul style="list-style-type: none"> * Due to imperfections in program material, variations in speaker output or asymmetry in room acoustics, the BALANCE control is not always set to the mid-position. 	<ul style="list-style-type: none"> * Set the MODE switches to MONO and adjust the BALANCE control so that the sound is heard from a point midway between the two speakers.

AMPLIFIER TROUBLESHOOTING CHART

OVER ALL PROGRAM SOURCES

SYMPTOM	PROBABLE CAUSE	CHECK POINT	
NO sound over all program sources	A. Defective speaker	1. Broken speaker cord 2. Voice coil, shorting or disconnection	Check continuity of speaker and cord Repair broken cord or replace speaker
	B. No power	1. No power comes to the power source 2. Defective on-off switch 3. Defective power cord 4. Loose plug contact 5. Fuse blowing If the fuse should blow as soon as it is replaced, the trouble may be attributed to: a. Power transformer shorting b. Electrolytic capacitor shorting c. B circuit shorting d. Diode shorting 6. Broken primary winding of power transformer	S ₁₂ PU ₀₀₁ F ₀₀₃ T ₀₀₁ C ₀₀₂ , C ₀₀₆ Check B circuit voltage with a tester. Diode rectifier T ₀₀₁
	C. Defective power circuit	Divergence of voltage specified in "SCHEMATIC DIAGRAM"	Measure voltage in power circuit and replace defective element (R ₀₀₁ , R ₉₀₆ , D ₀₀₁ ~D ₀₀₄ , D ₉₀₃ , D ₉₀₄ , C ₀₀₆ , C ₀₀₇ etc.)
	D. Defective low-frequency circuit	1. Divergence of voltage specified in "SCHEMATIC DIAGRAM" Note: If the PROTECTOR indicator should light up, push the POWER switch OFF, and after about 5 seconds, push it ON. If the indicator should still light up, push it OFF again and check for shorting of speaker terminals and improper connections between them. 2. Blown fuse If the fuse should blow as soon as it is replaced, the trouble may be attributed to: a. Defective main amplifier section b. Shorted power transistor c. Output terminals in contact with each other 3. Defective transistor 4. Electrolytic capacitor shorting	Measure voltage in low-frequency circuit and replace defective element. F ₀₀₁ ~F ₀₀₃ TR ₈₁₁ ~TR ₈₁₄ Check voltage in each section. Check voltage in each section.
	E. Troubles other than electrical	1. TAPE MONITOR switch is in PLAY BACK position 2. Incorrect use of SPEAKER selector switch	Turn the TAPE MONITOR switch to SOURCE. Speaker selector switch has to be in SYSTEM A position when the speaker systems are connected to the SYSTEM A terminals.

SYMPTOM	PROBABLE CAUSE		CHECK POINT
(continued)			Speaker selector switch has to be in SYSTEM B position when the speaker systems are connected to the SYSTEM B terminals.
Weak sound over all program sources	A. Defective speaker circuit	Voice coil shorting	Check voice coil for short circuit.
	B. Defective power circuit	Divergence of voltage specified in "SCHEMATIC DIAGRAM"	Measure voltage in power circuit and replace defective element.
	C. Defective low-frequency circuit	<ol style="list-style-type: none"> 1. Divergence of voltage specified in "SCHEMATIC DIAGRAM" 2. Insufficient capacity or short-circuit of capacitor 3. Aging transistor 	Measure voltage in low-frequency circuit and replace defective element. $C_{705} \sim C_{790}, C_{801} \sim C_{832}$ $TR_{701} \sim TR_{708}, TR_{801} \sim TR_{814}$
Distortion over all program sources	A. Defective speaker	<ol style="list-style-type: none"> 1. Defective voice coil 2. Defective cone or damper 	Check and replace.
	B. Defective power circuit	Divergence of voltage specified in "SCHEMATIC DIAGRAM"	Measure voltage in power circuit and replace defective element.
	C. Defective low-frequency circuit	<ol style="list-style-type: none"> 1. Divergence of voltage specified in "SCHEMATIC DIAGRAM" 2. Aging or weak transistor 	Measure voltage in low-frequency circuit and replace defective element. $TR_{701} \sim TR_{708}, TR_{801} \sim TR_{814},$ $TR_{601} \sim TR_{604}$
Hum over all program sources	A. Defective power circuit	Insufficient capacity of capacitor	$C_{002} \sim C_{007}$
	B. Defective low-frequency circuit	<ol style="list-style-type: none"> 1. Insufficient capacity of capacitor 2. Fixed resistor blown 	$C_{809}, C_{810}, C_{819}, C_{820}$ R_{825}, R_{826} and other fixed resistors
Noise over all program sources	A. Defective speaker	<ol style="list-style-type: none"> 1. Defective voice coil 2. Inner contact of speaker components 3. Defective cone or damper 	
	B. Defective power circuit	Divergence of voltage specified in "SCHEMATIC DIAGRAM"	Measure voltage in power circuit and replace defective element.
	C. Defective low-frequency circuit	<ol style="list-style-type: none"> 1. Aging or weak transistor 2. Defective master volume 	$TR_{601} \sim TR_{604}, TR_{701} \sim TR_{708},$ $TR_{801} \sim TR_{814}$ VR_{801}, VR_{802}
SPEAKER switch does not work	<ol style="list-style-type: none"> A. Defective headphone B. Speaker selector switch circuit defective 		S_{11a}, S_{11b} $S_{11c}, S_{11d}, S_{11e}$
HIGH FILTER switch does not work	Defective FILTER circuit		$S_{9a}, S_{9b}, C_{781}, C_{782}$

AMPLIFIER TROUBLESHOOTING CHART

SYMPTOM	PROBABLE CAUSE		CHECK POINT
LOW FILTER switch does not work	Defective FILTER circuit		S _{7a} , S _{7b} , C ₇₆₅ ~C ₇₆₈
LOUDNESS switch does not work	Defective LOUDNESS circuit		C ₇₀₁ ~C ₇₀₄ , R ₇₀₁ , R ₇₀₂ , VR ₇₀₁ , VR ₇₀₂ , S _{4a} , S _{4b}
TONE CONTROL does not work	Defective TONE CONTROL circuit	<ol style="list-style-type: none"> 1. Shorting or disconnection 2. Improper wiring or defective resistor 3. Tone control switch defective 	R ₇₀₅ ~R ₇₃₂ , R ₇₄₅ ~R ₇₈₂ , C ₇₀₇ ~C ₇₂₈ , C ₇₃₁ ~C ₇₃₈ , C ₇₄₅ ~C ₇₆₀ S _{5a} , S _{5b} , S _{6a} , S _{6b} S _{6c} , S _{6d}
MUTING switch does not work	Defective MUTING circuit		R ₇₁₀₅ ~R ₇₁₀₈ , S _{8a} , S _{8b}

FOR USE WITH A RECORD PLAYER (MAGNETIC) OR A TAPE DECK

SYMPTOM	PROBABLE CAUSE		CHECK POINT
No sound	A. Program source defective		Check and repair or replace.
	B. Defective overall section		See "No sound over all program sources".
	C. Defective equalizer amplifier	<ol style="list-style-type: none"> 1. Divergence of voltage specified in "SCHEMATIC DIAGRAM" 2. Shorting capacitor 3. Loose contact of rotary switch 4. Loose contact of input terminal or pin plug 5. Defective resistor 	Measure voltage in equalizer amplifier section and replace defective element. C ₆₀₁ , C ₆₀₃ , C ₆₀₄ , C ₆₀₈ , C ₆₁₀ , C ₆₁₁ , C ₆₁₅ ~C ₆₁₈ S _{1a} , S _{1b} , S _{1c} , S _{1d} , S _{1e} , S _{1f} R ₆₀₂ ~R ₆₀₈ , R ₆₁₅ ~R ₆₂₁
Weak sound	A. Program source defective		Check and repair or replace.
	B. Defective overall section		See "Weak sound over all program sources".
	C. Defective equalizer amplifier	<ol style="list-style-type: none"> 1. Divergence of voltage specified in "SCHEMATIC DIAGRAM" 2. Divergence of capacity of capacitor 3. Loose contact of rotary switch 4. Loose contact of input terminal or pin plug 5. Weak or aging transistor 	Measure voltage in equalizer amplifier section and replace defective element. C ₆₀₁ ~C ₆₀₄ , C ₆₀₈ ~C ₆₁₁ S _{1a} ~S _{1f} Check and repair. TR ₆₀₁ ~TR ₆₀₄

SYMPTOM	PROBABLE CAUSE		CHECK POINT
Distortion	A. Program source defective		Check and repair or replace.
	B. Defective overall section		See "Distortion over all program sources".
	C. Defective equalizer amplifier	<ol style="list-style-type: none"> 1. Divergence of voltage specified in "SCHEMATIC DIAGRAM" 2. Capacitor, shorting or disconnection 3. Defective resistor 4. Weak or aging transistor 	Measure voltage in equalizer amplifier and replace defective element. C ₆₀₁ ~C ₆₀₄ , C ₆₀₈ ~C ₆₁₁ R ₆₀₂ ~R ₆₁₂ , R ₆₁₅ ~R ₆₂₅ TR ₆₀₁ ~TR ₆₀₄
Hum	A. Program source defective		Check and repair or replace.
	B. Amplifier is O.K.	Improper connections	See "GENERAL SECTION".
	C. Defective overall section		See "Hum over all program sources".
	D. Defective equalizer amplifier	Insufficient capacity of capacitor	C ₀₀₂ , C ₀₀₅
Noisy	A. Program source defective		Check and repair or replace.
	B. Amplifier is O.K.		See "GENERAL SECTION".
	C. Defective overall section		See "Noise overall program sources"
	D. Defective equalizer amplifier	<ol style="list-style-type: none"> 1. Divergence of voltage specified in "SCHEMATIC DIAGRAM" 2. Capacitor, shorting or blowing 3. Defective resistor 4. Weak or aging transistor 	Measure voltage in equalizer amplifier and replace defective element C ₆₀₁ ~C ₆₀₄ , C ₆₀₈ ~C ₆₁₁ R ₆₀₂ ~R ₆₀₄ , R ₆₁₅ ~R ₆₃₀ TR ₆₀₁ ~TR ₆₀₄

AMPLIFIER TROUBLESHOOTING CHART / REMOVING THE FRONT PANEL, BONNET AND BOTTOM PLATE

OTHER PROGRAM SOURCES

SYMPTOM	PROBABLE CAUSE	CHECK POINT
A tuner connected to AUX inputs does not work normally.	<ul style="list-style-type: none"> * Original program defective * Improper or incorrect connection * Amplifier defective 	See "Over all program sources".
A tape recorder connected to the amplifier does not work normally.	<ul style="list-style-type: none"> * Original program defective * Improper or incorrect connection * Amplifier defective 	See "Over all program sources".
Broadcast is not recorded well on a tape through the amplifier.	<ul style="list-style-type: none"> * Defective tuner * Recording tape or tape recorder defective 	Check and repair or replace.
Poor recording from records or tapes.	<ul style="list-style-type: none"> * Tape or tape recorder defective * Improper or incorrect connection * Records, record players, tape heads or an AUX inputs defective * Equalizer amplifier section defective 	Check and repair or replace. Check and correct. Check and repair or replace. See "Defective equalizer amplifier".

EXPLODED VIEW OF CHASSIS

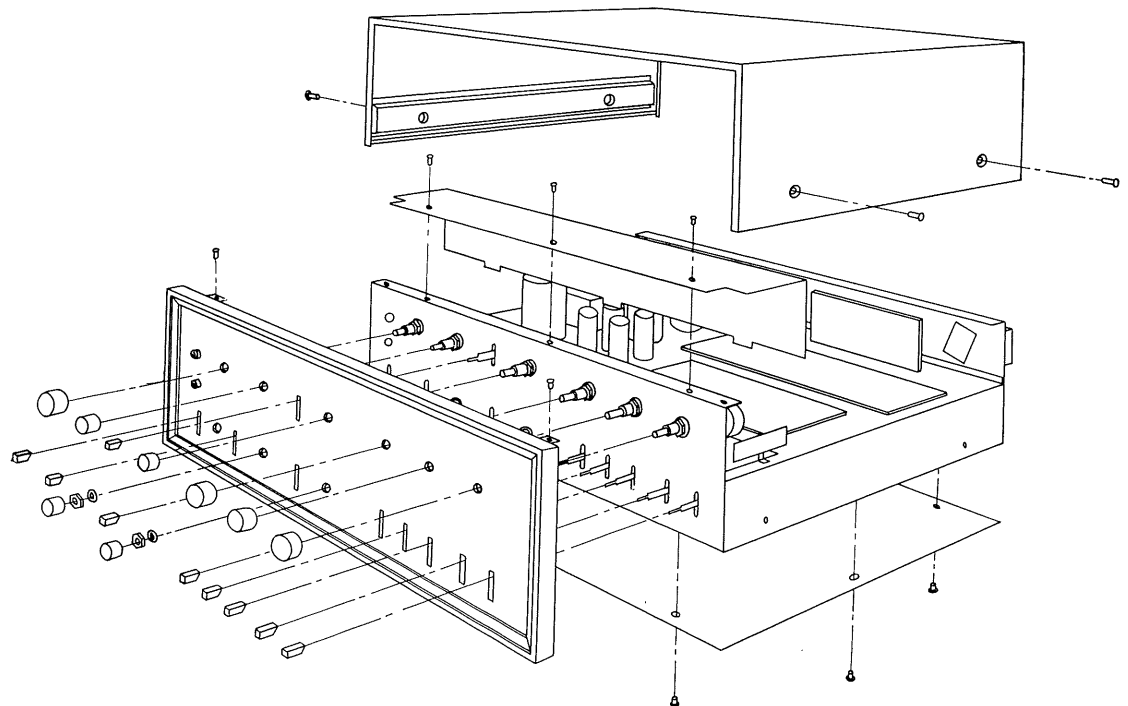

PRINTED CIRCUIT SHEETS

HEAD AMPLIFIER (TRHA-6B)

POSITION OF PARTS

R601...2 C	R616...4 B	R631...2 A	C613...1 B
R602...3 C	R617...1 B	R632...3 B	C614...4 B
R603...1 C	R618...4 B		C615...1 B
R604...4 C	R619...2 A	C601...2 C	C616...4 B
R605...2 C	R620...3 A	C602...3 C	C617...1 A
R606...3 C	R621...2 A	C603...1 C	C618...4 A
R607...1 C	R622...3 A	C604...4 C	C619...1 A
R608...4 C	R623...2 A	C605...1 C	C620...4 A
R609...2 B	R624...3 A	C606...4 C	
R610...3 B	R625...1 A	C607...1 B	TR601..2 C
R611...2 B	R626...4 A	C608...4 B	TR602..3 C
R612...3 B	R627...1 A	C609...2 B	TR603..2 B
R613...2 B	R628...4 A	C610...3 B	TR604..3 B
R614...3 B	R629...1 B	C611...2 B	
R615...1 B	R630...4 B	C612...3 B	

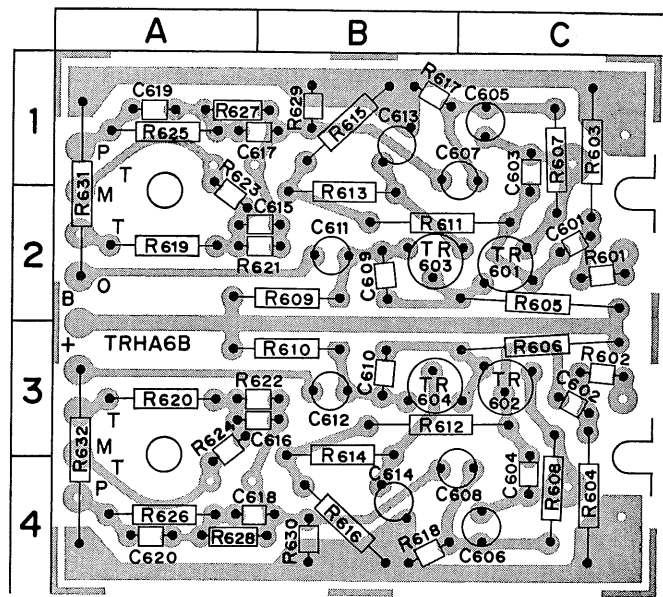

PRE-AMPLIFIER (TR-70A)

POSITION OF PARTS

R725...2 A	R788...1 B	R7104..1 C	R7116..1 D	C737...2 B	C765...2 B	C777...2 C	C789...2 D
R726...1 A	R793...2 B	R7105..2 C	R7119..2 D	C738...1 B	C766...1 B	C778...2 C	C790...1 D
R731...2 B	R794...1 B	R7106..1 C	R7120..1 D	C739...2 A	C767...2 B	C779...2 D	
R732...1 B	R795...2 C	R7107..2 C	R7121..2 D	C740...1 A	C768...1 B	C780...1 D	TR701..2 A
R733...2 A	R796...1 C	R7108..1 C	R7122..1 D	C741...2 A	C769...2 B	C781...2 D	TR702..1 A
R781...1 A	R797...2 C	R7109..2 D		C742...1 A	C770...1 A	C782...1 D	TR703..2 B
R782...1 B	R798...1 C	R7110..1 D	C705...2 A	C743...2 B	C771...2 C	C783...2 D	TR704..1 B
R783...2 B	R799...2 C	R7111..2 D	C706...1 A	C744...1 B	C772...1 C	C784...1 D	TR705..2 C
R784...1 B	R7100..1 C	R7112..1 D	C729...2 A	C745...2 B	C773...2 C	C785...2 D	TR706..1 C
R785...2 B	R7101..2 C	R7113..2 D	C730...1 A	C746...1 B	C774...1 C	C786...1 D	TR707..2 D
R786...1 B	R7102..1 C	R7114..1 D	C735...2 A	C747...2 B	C775...2 C	C787...2 D	TR708..1 D
R787...2 B	R7103..2 C	R7115..2 D	C736...1 A	C748...1 B	C776...1 C	C788...1 D	

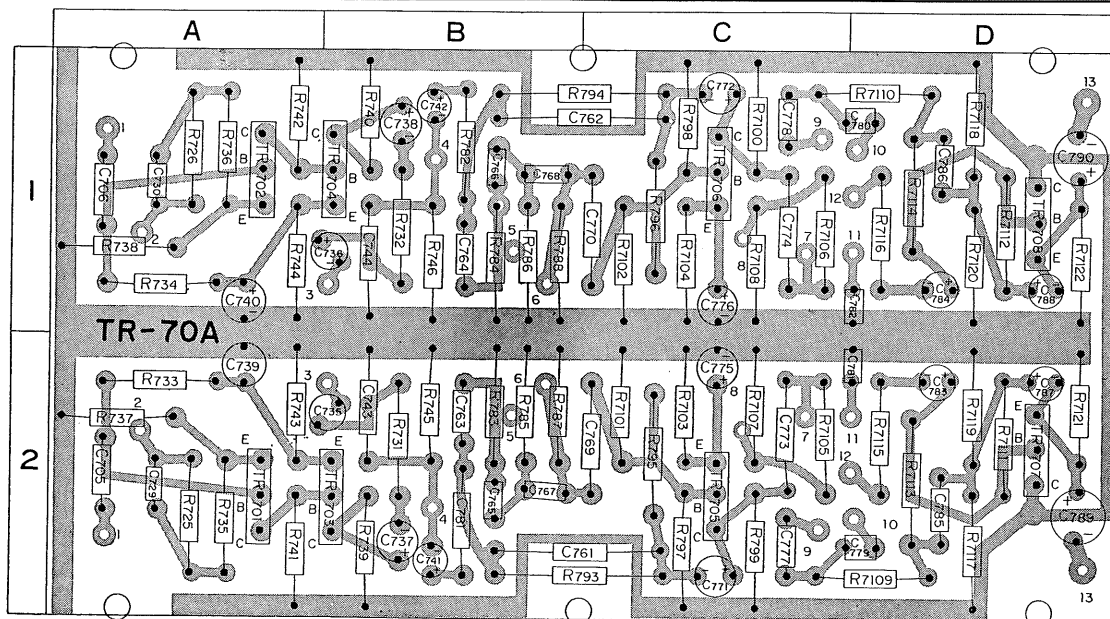

PRINTED CIRCUIT SHEETS

MAIN AMPLIFIER (TR-8LB)

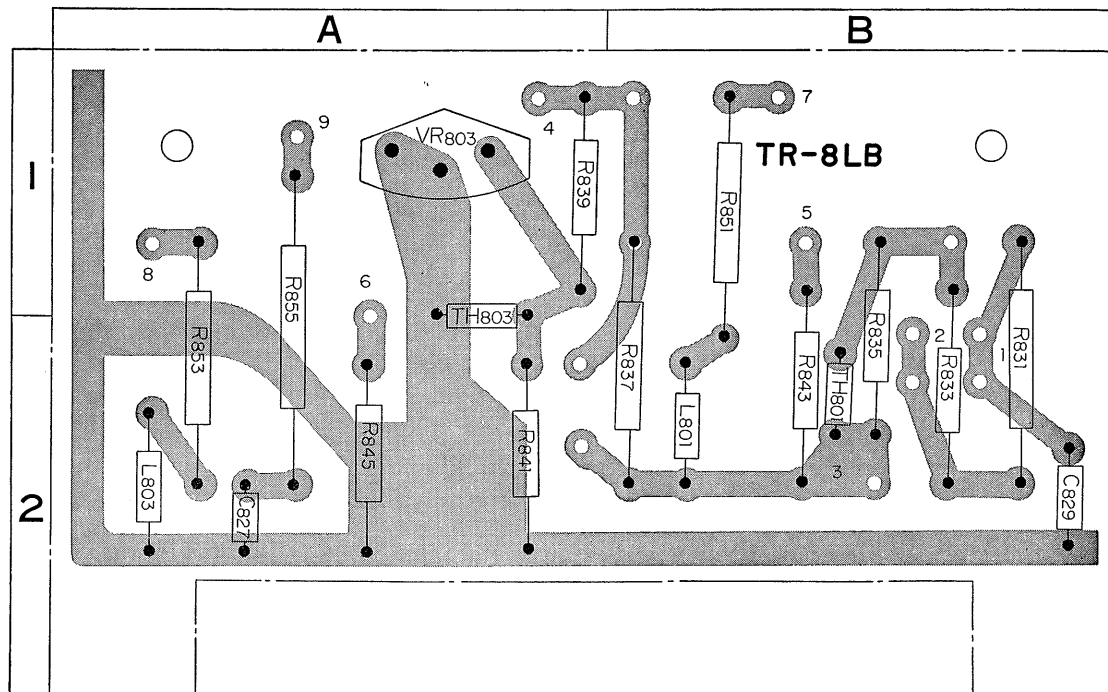

POSITION OF PARTS

- R831 2 B
- R833 2 B
- R835 2 B
- R837 2 B
- R839 1 A
- R841 2 A
- R843 2 B
- R845 2 A
- R851 1 B
- R853 2 A
- R855 2 A

- C827 2 A
- C829 2 B

- VR803 . . . 1 A

- TH801 . . . 2 B
- TH803 . . . 2 A

- L801 2 B
- L803 2 A

MAIN AMPLIFIER (TR-8RB)

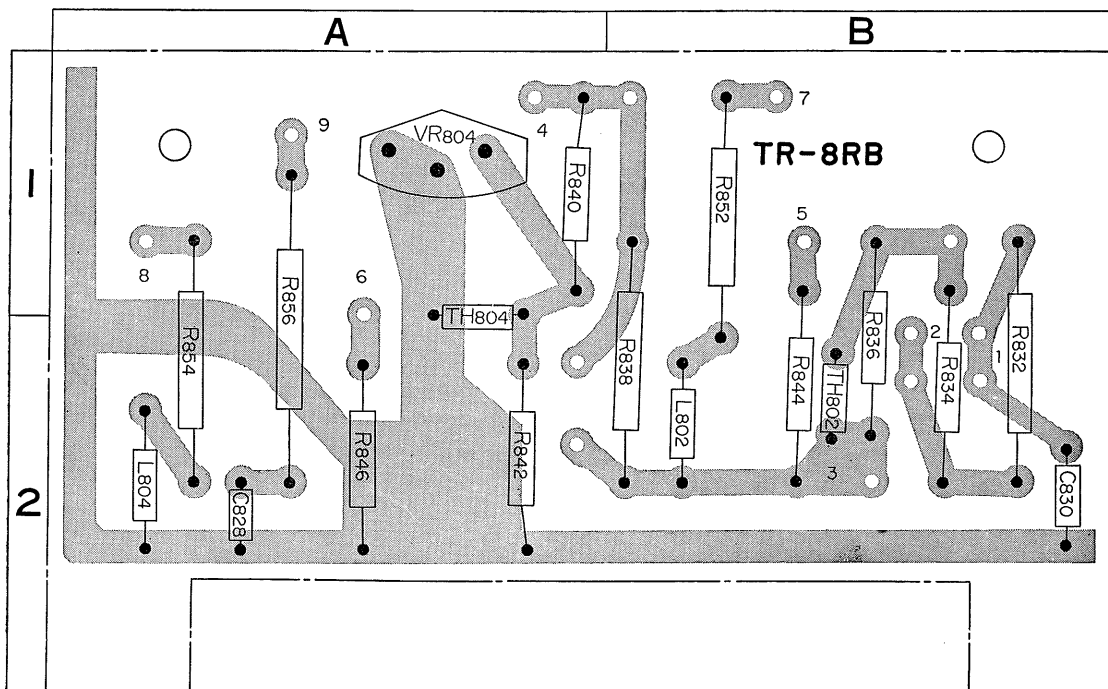

POSITION OF PARTS

- R832 2 B
- R834 2 B
- R836 2 B
- R838 2 B
- R840 1 A
- R842 2 A
- R844 2 B
- R846 2 A
- R852 1 B
- R854 2 A
- R856 2 A

- C828 2 A
- C830 2 B

- VR804 . . . 1 A

- TH802 . . . 2 B
- TH804 . . . 2 A

- L802 2 B
- L804 2 A

MAIN AMPLIFIER DRIVER (TR-80A)

POSITION OF PARTS

R801 ... 1 B	R813 ... 2 A	R825 ... 1 A	C808 ... 1 C	C824 ... 2 D
R802 ... 1 C	R814 ... 2 D	R826 ... 1 D	C809 ... 1 B	C831 ... 2 A
R803 ... 2 B	R815 ... 2 B	R827 ... 2 A	C810 ... 1 C	C832 ... 2 D
R804 ... 2 C	R816 ... 2 C	R828 ... 2 D	C811 ... 2 B	VR801 ... 1 B
R805 ... 2 B	R817 ... 1 A		C812 ... 2 C	VR802 ... 1 C
R806 ... 2 C	R818 ... 1 D	C801 ... 1 B	C813 ... 2 B	
R807 ... 2 B	R819 ... 1 A	C802 ... 1 C	C814 ... 2 C	TR801 ... 1 B
R808 ... 2 C	R820 ... 1 D	C803 ... 2 B	C815 ... 1 A	TR802 ... 1 C
R809 ... 1 A	R821 ... 1 A	C804 ... 2 C	C816 ... 1 D	TR803 ... 1 B
R810 ... 1 D	R822 ... 1 D	C805 ... 2 B	C821 ... 1 A	TR804 ... 1 C
R811 ... 2 A	R823 ... 2 A	C806 ... 2 C	C822 ... 1 D	
R812 ... 2 D	R824 ... 2 D	C807 ... 1 B	C823 ... 2 A	

POWER BLOCK (TR-90A)

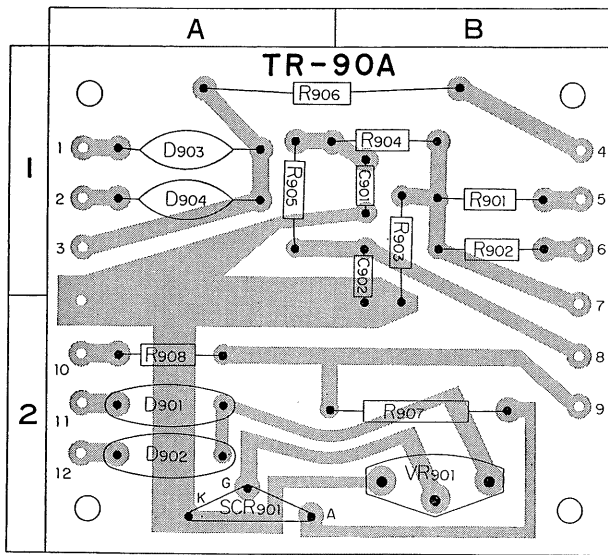

POSITION OF PARTS

R901 ... 1 B
R902 ... 1 B
R903 ... 1 B
R904 ... 1 B
R905 ... 1 A
R906 ... 1 A
R907 ... 2 B
R908 ... 2 A
C901 ... 1 B
C902 ... 1 B
VR901 ... 2 B
D901 ... 2 A
D902 ... 2 A
D903 ... 1 A
D904 ... 1 A
SCR901 2 A

POWER DIODE BRIDGE (DS-1A)

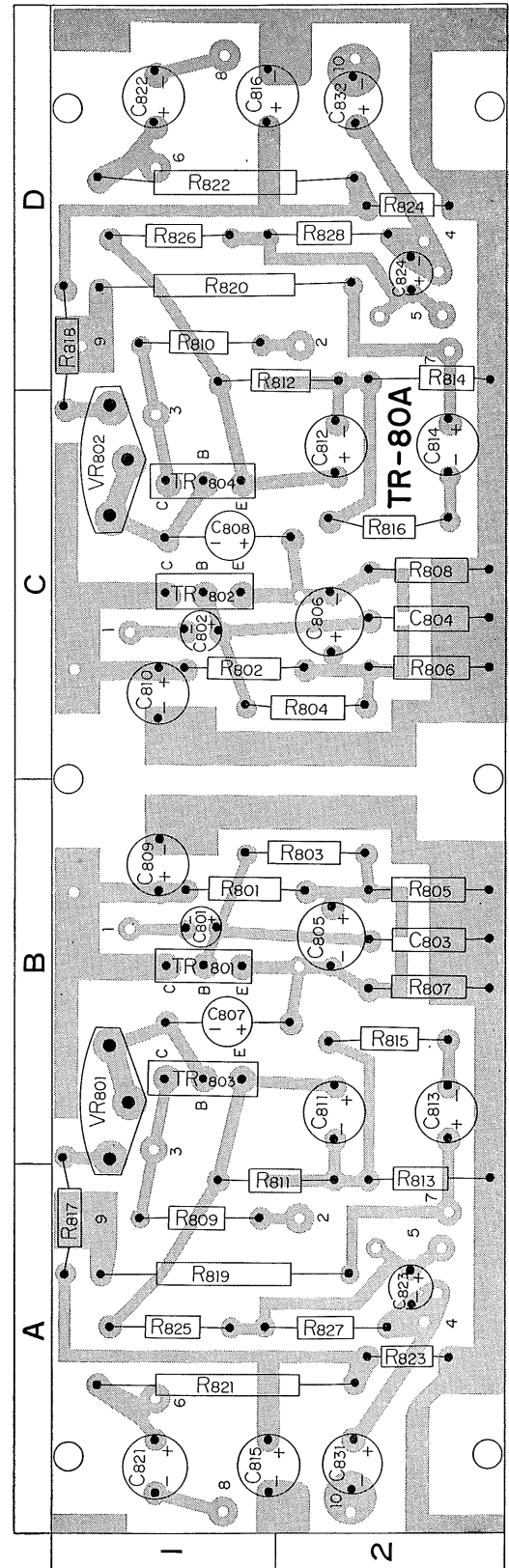
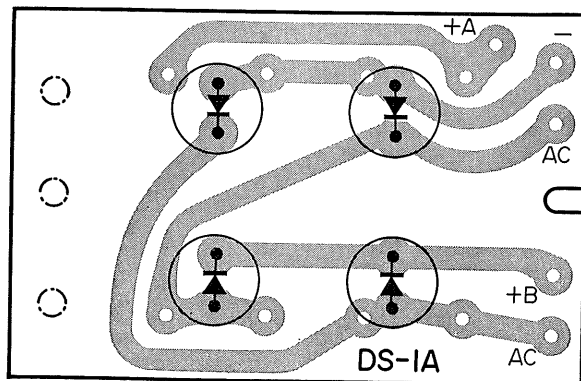

SELECTOR CHART

Remove the bonnet and look at the switches from the back side of the amplifier. This chart tells you the location of their contact and supporting points. The smaller the circle, the nearer the points are located to the back of the amplifier.

- indicates a contact point of the selector switch.
- ⊙ indicates a supporting point of the selector switch.
- ▲ indicates a terminal point of the selector switch.

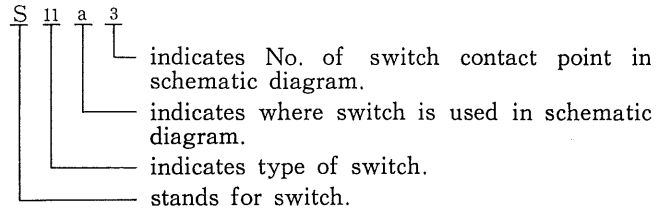
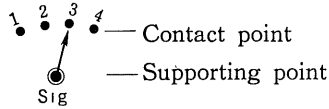

FUNCTION

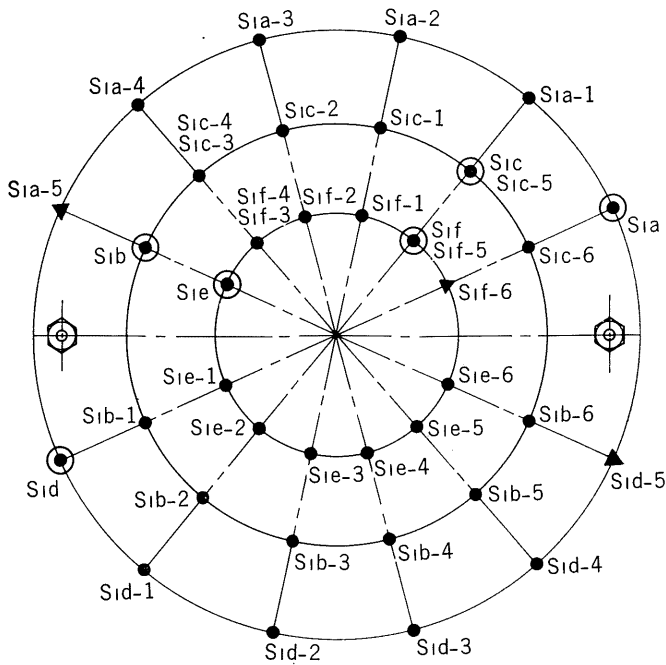

⊠
LOCATION OF STOPPER

POSITION OF SWITCHES S₁ (a~f)

S _{1a} ...1 B	1. TAPE HEAD 19 cm/s
S _{1b} ...1 A	2. TAPE HEAD 9.5 cm/s
S _{1c} ...1 B	3. PHONO 1
S _{1d} ...1 D	4. PHONO 2
S _{1e} ...1 C	5. AUX 1
S _{1f} ...1 D	6. AUX 2

SPEAKERS SWITCH

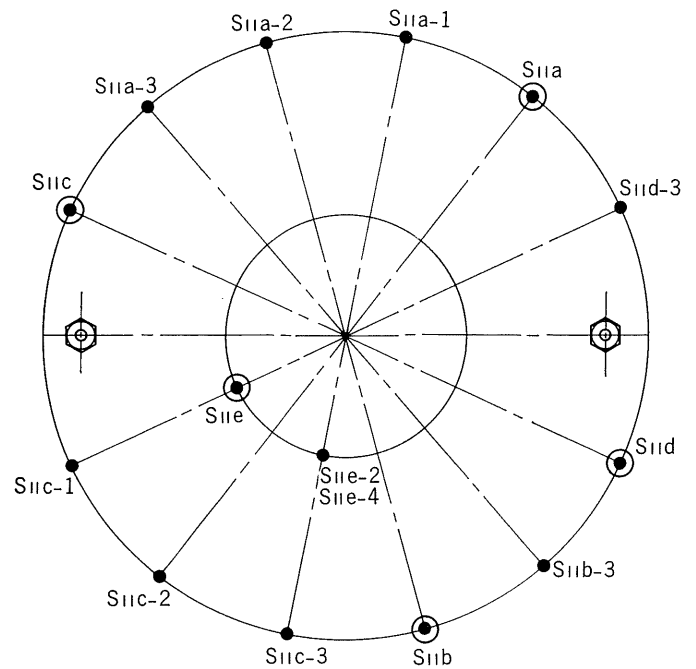

⊠
LOCATION OF STOPPER

POSITION OF SWITCHES S₁₁ (a~d)

S _{11a} ...7 B	1. SYSTEM A
S _{11b} ...7 B	2. SYSTEM B
S _{11c} ...7 D	2. SYSTEM A+B
S _{11d} ...7 D	4. SPEAKER OFF
S _{11e} ...7 B	

TONE CONTROL (BASS)

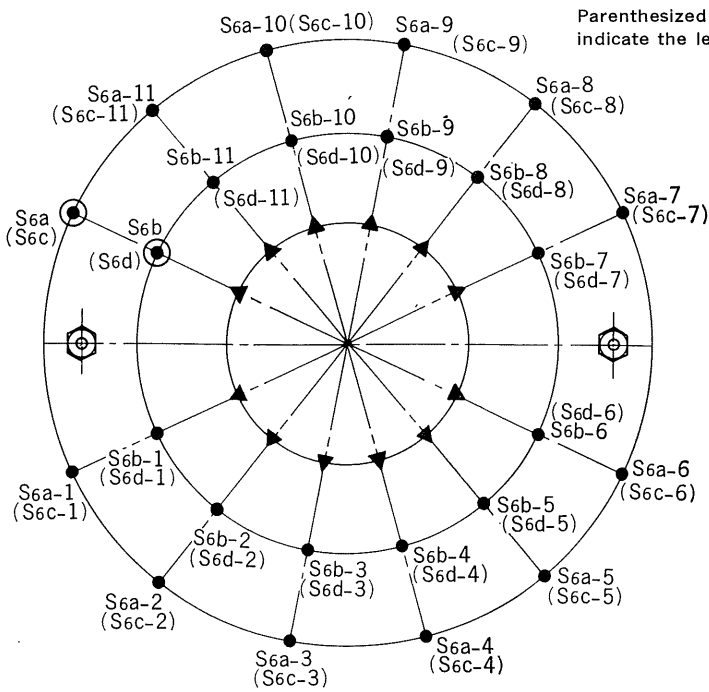

LOCATION OF STOPPER

POSITION OF SWITCHES S₆ (a~b)

S _{6a}3 A	1~5 CUT
S _{6b}3 B	6 FLAT
S _{6c}3 C	7~11 BOOST
S _{6d}3 D	

TONE CONTROL (TREBLE)

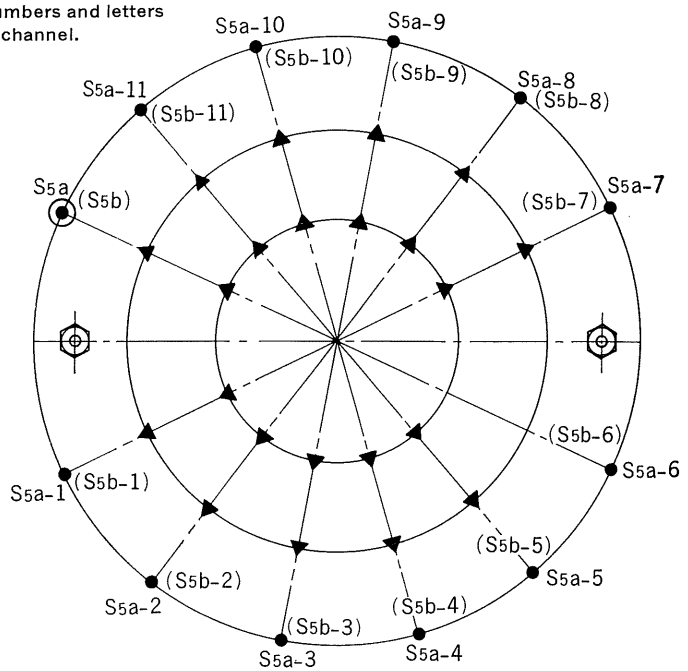

LOCATION OF STOPPER

POSITION OF SWITCHES S₅ (a~b)

S _{5a}2 A	1~5 CUT
S _{5b}2 C	6 FLAT
	7~11 BOOST

ALIGNMENT

MAIN-AMP SECTION OUTPUT ADJUSTMENT

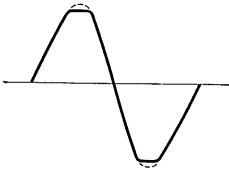
STEP	CONNECTIONS & ALIGN	REMARKS
1.	Set VOLUME control to minimum.	<p>Oscilloscope required: oscillation frequency of 20 to 20,000 Hz and output voltage of more than 200mV.</p> <p>When measuring, BALANCE control to mid-position, TAPE MONITOR switch to SOURCE, MODE switches to STEREO, TONE controls to 0 and other accessory switches to OFF position.</p> 
2.	Set oscillator to 1,000Hz and connect it to AUX 2 of channel L.	
3.	Set FUNCTION selector switch to AUX 2	
4.	Connect a 8-ohm (or 16-ohm) load resistor (minimum rating of 50 watts) to SYSTEM A LEFT speaker terminal.	
5.	Set SPEAKER selector switch to SYSTEM A.	
6.	Connect oscilloscope to speaker terminal.	
7.	Turn POWER switch ON; turn VOLUME control clockwise little by little; and check output at speaker terminal by using oscilloscope.	
8.	Adjust VR ₈₀₁ so that both crests of output wave form are clipped. For channel R, follow same procedure as above. In Step 8, adjust VR ₈₀₂ for clipped crests of output wave.	

MAIN-AMP SECTION CURRENT ADJUSTMENT

STEP	AMMETER (TESTER)	CONNECTIONS & ALIGN	REMARKS
1.		Remove F ₀₀₁ and F ₀₀₂ .	<p>Ammeter required: 100mA or 50mA range</p> <p>Be sure to turn POWER switch on and then connect ammeter.</p>
2.		Set VR ₈₀₃ and VR ₈₀₄ to minimum clockwise position.	
3.		Turn POWER switch ON.	
4.	Set to 100mA range.	Set ammeter in place of F ₀₀₁ . Connect its ⊕ terminal to B ₀ , and its ⊖ terminal to B ₁ in schematic diagram.	
5.		Turn VR ₈₀₃ and adjust current to 24~28 mA at room temperature of less than 25°C and to 20~24 mA at more than 25°C.	
6.		Turn POWER switch OFF and reset F ₀₀₁ to its original position.	
7.	Set to 100mA range.	Turn POWER switch ON and set ammeter in place of F ₀₀₂ . Connect its ⊕ terminal to B ₀ , and its ⊖ terminal B ₂ in schematic diagram.	
8.		Turn VR ₈₀₄ and adjust current to 22~26mA at room temperature of less than 25°C and to 18~22 mA at more than 25°C.	

TEST POINTS

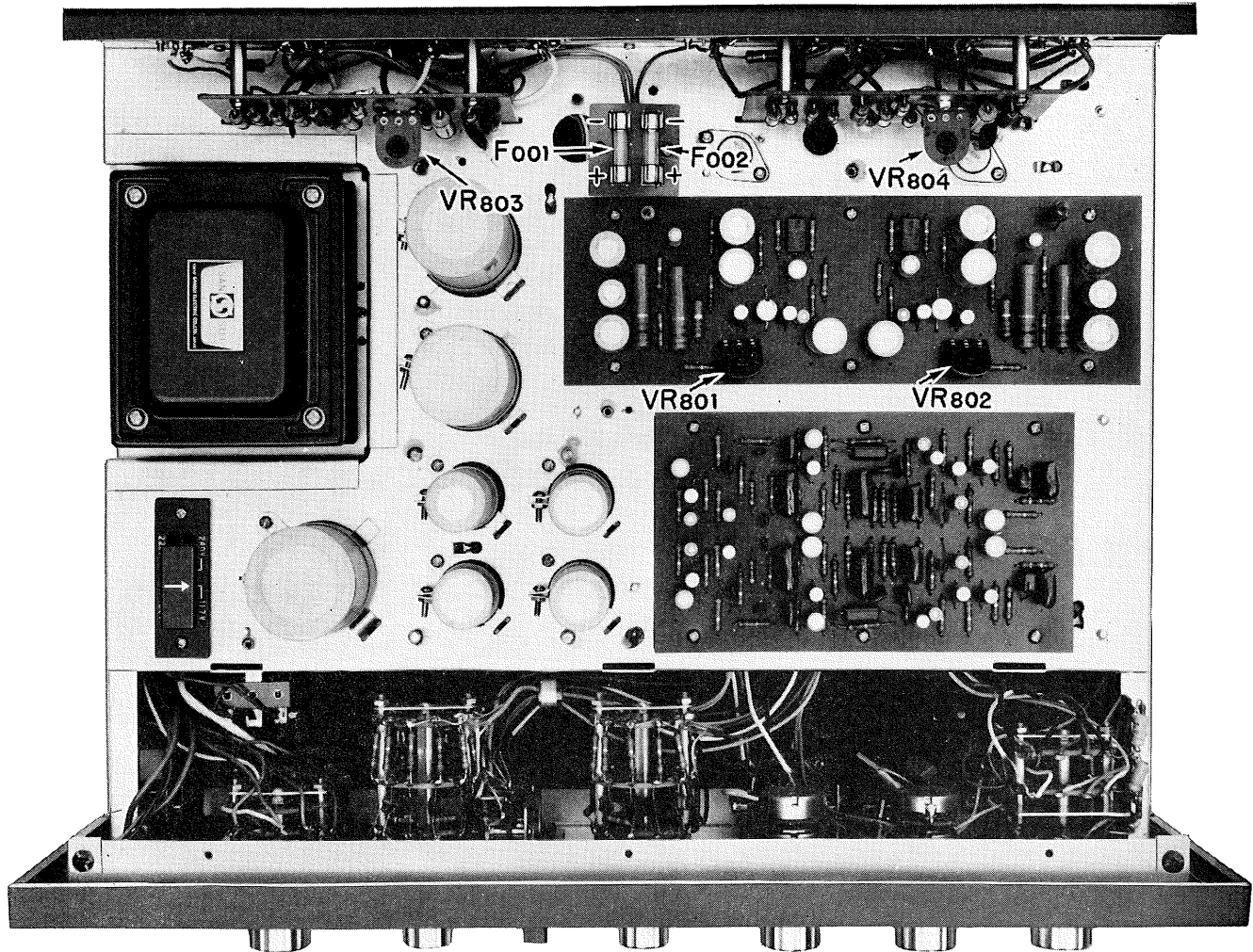

PARTS LAYOUT

TOP VIEW OF UPPER CHASSIS

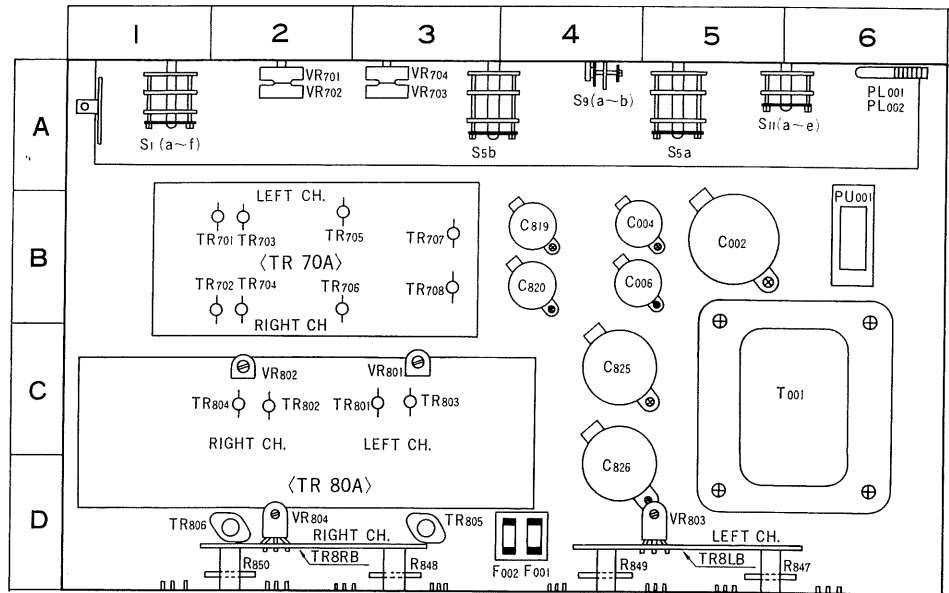

TOP VIEW OF BACK PANEL

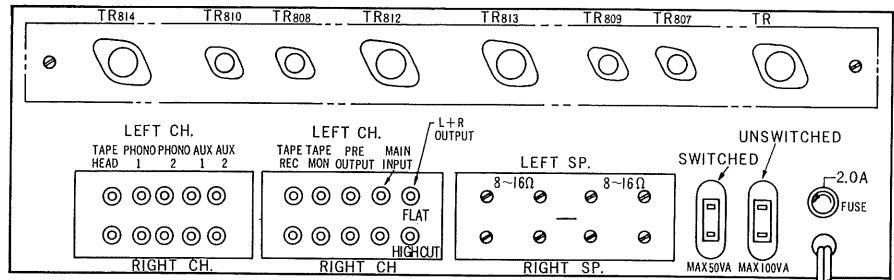

TOP VIEW OF LOWER CHASSIS

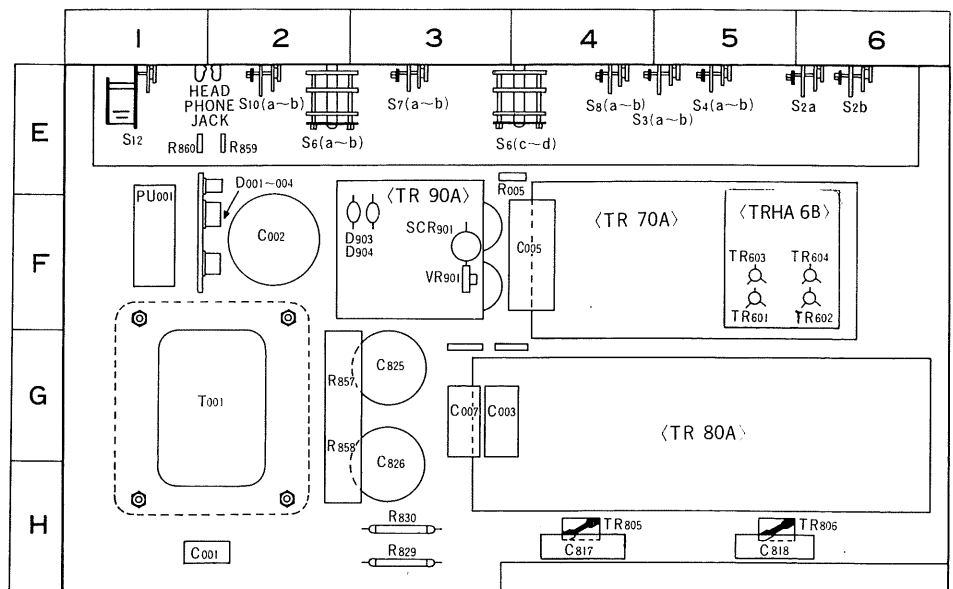

BLOCK DIAGRAM

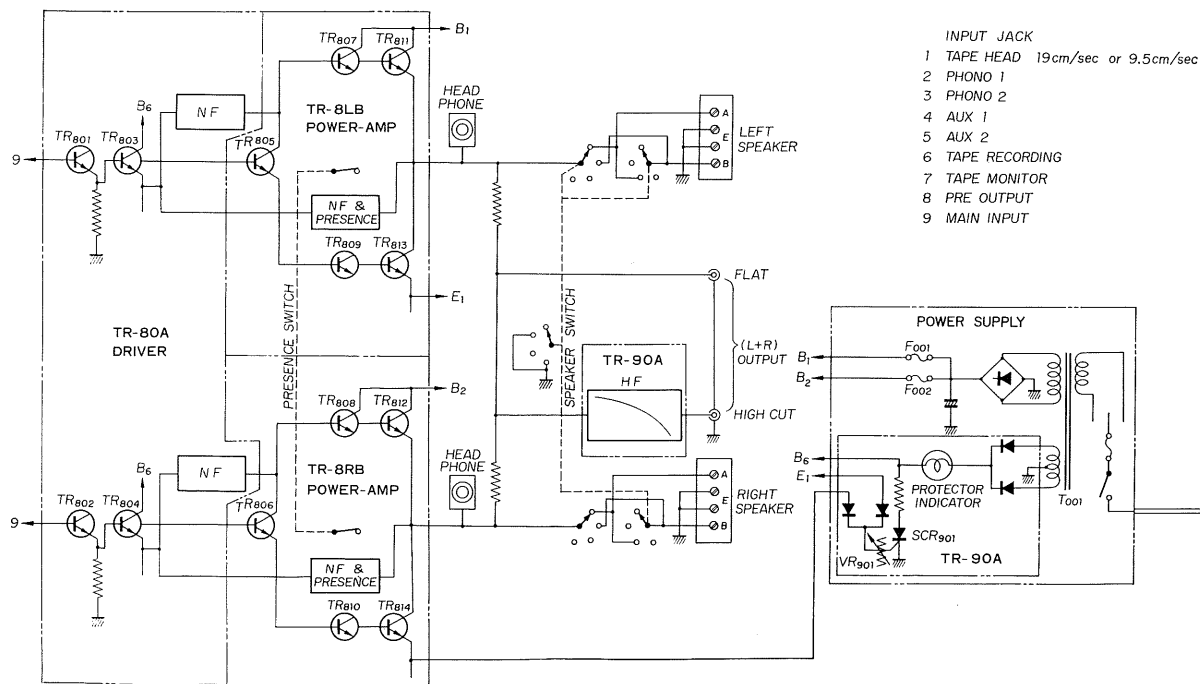
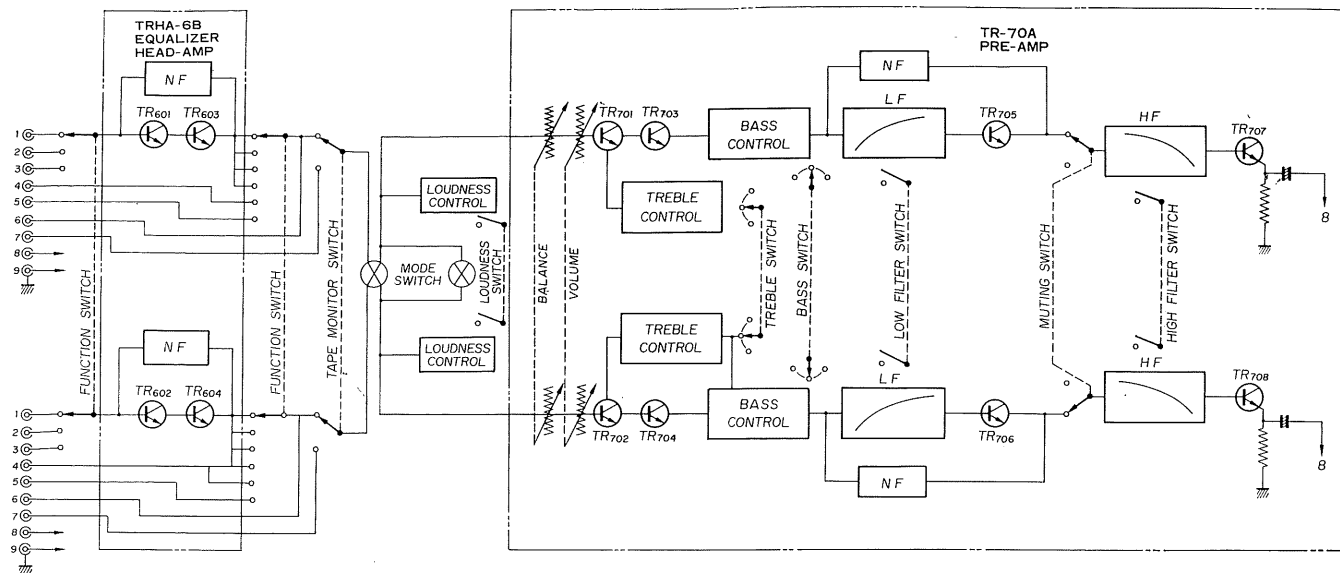

- INPUT JACK
- 1 TAPE HEAD 19cm/sec or 9.5cm/sec
 - 2 PHONO 1
 - 3 PHONO 2
 - 4 AUX 1
 - 5 AUX 2
 - 6 TAPE RECORDING
 - 7 TAPE MONITOR
 - 8 PRE OUTPUT
 - 9 MAIN INPUT

PARTS LIST

- A:** Parts No.
B: Parts Name
C: Position of Part (Co-ordinate number and letter in Schematic Diagram)
D: Position of Part (Co-ordinate number and letter on Parts layout or name of Printed Circuit)

A	B	C	D
R001	5.6kΩ ½W ±10% Carbon Fixed Resistor	3 E	3 G
R002	3.9kΩ ½W ±10% Carbon Fixed Resistor	4 E	3 G
R003	3.3kΩ ½W ±10% Carbon Fixed Resistor	4 E	3 E
R601	1kΩ ¼W ±10% Carbon Fixed Resistor	1 A	TRHA-6B
R602	1kΩ ¼W ±10% Carbon Fixed Resistor	1 C	TRHA-6B
R603	680kΩ ¼W ±10% Carbon Fixed Resistor	1 B	TRHA-6B
R604	680kΩ ¼W ±10% Carbon Fixed Resistor	1 D	TRHA-6B
R605	100kΩ ¼W ±10% Carbon Fixed Resistor	1 A	TRHA-6B
R606	100kΩ ¼W ±10% Carbon Fixed Resistor	1 C	TRHA-6B
R607	1.8kΩ ¼W ±10% Carbon Fixed Resistor	1 B	TRHA-6B
R608	1.8kΩ ¼W ±10% Carbon Fixed Resistor	1 D	TRHA-6B
R609	6.8kΩ ¼W ±10% Carbon Fixed Resistor	1 A	TRHA-6B
R610	6.8kΩ ¼W ±10% Carbon Fixed Resistor	1 C	TRHA-6B
R611	390kΩ ¼W ±10% Carbon Fixed Resistor	1 B	TRHA-6B
R612	390kΩ ¼W ±10% Carbon Fixed Resistor	1 D	TRHA-6B
R613	220kΩ ¼W ±10% Carbon Fixed Resistor	1 B	TRHA-6B
R614	220kΩ ¼W ±10% Carbon Fixed Resistor	1 D	TRHA-6B
R615	680Ω ¼W ±10% Carbon Fixed Resistor	1 B	TRHA-6B
R616	680Ω ¼W ±10% Carbon Fixed Resistor	1 D	TRHA-6B
R617	470Ω ¼W ±10% Carbon Fixed Resistor	1 B	TRHA-6B
R618	470Ω ¼W ±10% Carbon Fixed Resistor	1 D	TRHA-6B
R619	12kΩ ¼W ±10% Carbon Fixed Resistor	1 B	TRHA-6B
R620	12kΩ ¼W ±10% Carbon Fixed Resistor	1 D	TRHA-6B
R621	1MΩ ¼W ±10% Carbon Fixed Resistor	1 B	TRHA-6B
R622	1MΩ ¼W ±10% Carbon Fixed Resistor	1 D	TRHA-6B
R623	25kΩ ¼W ±10% Carbon Fixed Resistor	1 B	TRHA-6B
R624	25kΩ ¼W ±10% Carbon Fixed Resistor	1 D	TRHA-6B
R625	25kΩ ¼W ±10% Carbon Fixed Resistor	1 B	TRHA-6B
R626	25kΩ ¼W ±10% Carbon Fixed Resistor	1 D	TRHA-6B
R627	470kΩ ¼W ±10% Carbon Fixed Resistor	1 B	TRHA-6B
R628	470kΩ ¼W ±10% Carbon Fixed Resistor	1 D	TRHA-6B
R629	4.7kΩ ¼W ±10% Carbon Fixed Resistor	1 B	TRHA-6B
R630	4.7kΩ ¼W ±10% Carbon Fixed Resistor	1 D	TRHA-6B
R631	82kΩ ¼W ±10% Carbon Fixed Resistor	1 B	TRHA-6B
R632	82kΩ ¼W ±10% Carbon Fixed Resistor	1 D	TRHA-6B
R633	100Ω ¼W ±10% Carbon Fixed Resistor	1 B	1 A
R634	100Ω ¼W ±10% Carbon Fixed Resistor	1 D	1 A
R635	8.2kΩ ¼W ±10% Carbon Fixed Resistor	1 B	1 A
R636	8.2kΩ ¼W ±10% Carbon Fixed Resistor	1 D	1 A
R637	68kΩ ¼W ±10% Carbon Fixed Resistor	1 A	6 H
R638	68kΩ ¼W ±10% Carbon Fixed Resistor	1 C	6 H
R639	180kΩ ¼W ±10% Carbon Fixed Resistor	1 B	6 H
R640	180kΩ ¼W ±10% Carbon Fixed Resistor	1 D	6 H
R701	33kΩ ¼W ±10% Carbon Fixed Resistor	2 B	5 E
R702	33kΩ ¼W ±10% Carbon Fixed Resistor	2 D	5 E

A	B	C	D
R703	100kΩ ¼W ±10% Carbon Fixed Resistor	2 A	5 A
R704	100kΩ ¼W ±10% Carbon Fixed Resistor	2 C	3 A
R705	560Ω ¼W ±10% Carbon Fixed Resistor	2 A	5 A
R706	560Ω ¼W ±10% Carbon Fixed Resistor	2 C	3 A
R707	820Ω ¼W ±10% Carbon Fixed Resistor	2 A	5 A
R708	820Ω ¼W ±10% Carbon Fixed Resistor	2 C	3 A
R709	1.5kΩ ¼W ±10% Carbon Fixed Resistor	2 A	5 A
R710	1.5kΩ ¼W ±10% Carbon Fixed Resistor	2 C	3 A
R711	3.3kΩ ¼W ±10% Carbon Fixed Resistor	2 A	5 A
R712	3.3kΩ ¼W ±10% Carbon Fixed Resistor	2 C	3 A
R713	8.2kΩ ¼W ±10% Carbon Fixed Resistor	2 A	5 A
R714	8.2kΩ ¼W ±10% Carbon Fixed Resistor	2 C	3 A
R715	33kΩ ¼W ±10% Carbon Fixed Resistor	2 A	5 A
R716	33kΩ ¼W ±10% Carbon Fixed Resistor	2 C	3 A
R717	12kΩ ¼W ±10% Carbon Fixed Resistor	2 B	5 A
R718	12kΩ ¼W ±10% Carbon Fixed Resistor	2 D	3 A
R719	5.6kΩ ¼W ±10% Carbon Fixed Resistor	2 B	5 A
R720	5.6kΩ ¼W ±10% Carbon Fixed Resistor	2 D	3 A
R721	1.8kΩ ¼W ±10% Carbon Fixed Resistor	2 B	5 A
R722	1.8kΩ ¼W ±10% Carbon Fixed Resistor	2 D	3 A
R723	22kΩ ¼W ±10% Carbon Fixed Resistor	2 B	5 A
R724	22kΩ ¼W ±10% Carbon Fixed Resistor	2 D	3 A
R725	68Ω ¼W ±10% Carbon Fixed Resistor	2 B	TR-70A
R726	68Ω ¼W ±10% Carbon Fixed Resistor	2 D	TR-70A
R727	150kΩ ¼W ±10% Carbon Fixed Resistor	3 A	2 E
R728	150kΩ ¼W ±10% Carbon Fixed Resistor	3 C	4 E
R729	150kΩ ¼W ±10% Carbon Fixed Resistor	3 B	2 E
R730	150kΩ ¼W ±10% Carbon Fixed Resistor	3 D	4 E
R731	820Ω ¼W ±10% Carbon Fixed Resistor	2 B	TR-70A
R732	820Ω ¼W ±10% Carbon Fixed Resistor	2 D	TR-70A
R733	680kΩ ¼W ±10% Carbon Fixed Resistor	2 B	TR-70A
R734	680kΩ ¼W ±10% Carbon Fixed Resistor	2 D	TR-70A
R735	560Ω ¼W ±10% Carbon Fixed Resistor	2 B	TR-70A
R736	560Ω ¼W ±10% Carbon Fixed Resistor	2 D	TR-70A
R737	3.9kΩ ¼W ±10% Carbon Fixed Resistor	2 B	TR-70A
R738	3.9kΩ ¼W ±10% Carbon Fixed Resistor	2 D	TR-70A
R739	5.6kΩ ¼W ±10% Carbon Fixed Resistor	2 B	TR-70A
R740	5.6kΩ ¼W ±10% Carbon Fixed Resistor	2 D	TR-70A
R741	68kΩ ¼W ±10% Carbon Fixed Resistor	2 B	TR-70A
R742	68kΩ ¼W ±10% Carbon Fixed Resistor	2 D	TR-70A
R743	1.5kΩ ¼W ±10% Carbon Fixed Resistor	2 B	TR-70A
R744	1.5kΩ ¼W ±10% Carbon Fixed Resistor	2 D	TR-70A
R747	390kΩ ¼W ±10% Carbon Fixed Resistor	2 A	5 A
R748	390kΩ ¼W ±10% Carbon Fixed Resistor	2 C	3 A
R749	390kΩ ¼W ±10% Carbon Fixed Resistor	2 A	5 A
R750	390kΩ ¼W ±10% Carbon Fixed Resistor	2 C	3 A
R751	390kΩ ¼W ±10% Carbon Fixed Resistor	2 A	5 A
R752	390kΩ ¼W ±10% Carbon Fixed Resistor	2 C	3 A

PARTS LIST

- A:** Parts No.
B: Parts Name
C: Position of Part (Co-ordinate number and letter in Schematic Diagram)
D: Position of Part (Co-ordinate number and letter on Parts layout or name of Printed Circuit)

A	B	C	D
R827	820Ω ¼W ±10% Carbon Fixed Resistor	6 A	TR-80A
R828	820Ω ¼W ±10% Carbon Fixed Resistor	6 C	TR-80A
R829	220Ω 5 W ±10% Oxide-coated Resistor	6 A	3 H
R830	220Ω 5 W ±10% Oxide-coated Resistor	6 C	3 H
R831	3.9kΩ 1 W ±10% Carbon Fixed Resistor	6 A	TR-8LB
R832	3.9kΩ 1 W ±10% Carbon Fixed Resistor	6 C	TR-8RB
R833	100Ω ½W ±10% Carbon Fixed Resistor	6 B	TR-8LB
R834	100Ω ½W ±10% Carbon Fixed Resistor	6 D	TR-8RB
R835	82Ω ½W ±10% Carbon Fixed Resistor	6 B	TR-8LB
R836	82Ω ½W ±10% Carbon Fixed Resistor	6 D	TR-8RB
R837	3.9kΩ 1 W ±10% Carbon Fixed Resistor	6 B	TR-8LB
R838	3.9kΩ 1 W ±10% Carbon Fixed Resistor	6 D	TR-8RB
R839	82Ω ½W ±10% Carbon Fixed Resistor	6 B	TR-8LB
R840	82Ω ½W ±10% Carbon Fixed Resistor	6 D	TR-8RB
R841	220Ω ½W ±10% Carbon Fixed Resistor	6 B	TR-8LB
R842	220Ω ½W ±10% Carbon Fixed Resistor	6 D	TR-8RB
R843	100Ω ½W ±10% Carbon Fixed Resistor	6 B	TR-8LB
R844	100Ω ½W ±10% Carbon Fixed Resistor	6 D	TR-8RB
R845	100Ω ½W ±10% Carbon Fixed Resistor	6 B	TR-8LB
R846	100Ω ½W ±10% Carbon Fixed Resistor	6 D	TR-8RB
R847	10Ω ½W ±10% Noiseless Carbon Resistor	6 B	5 D
R848	10Ω ½W ±10% Noiseless Carbon Resistor	6 D	3 D
R849	10Ω ½W ±10% Noiseless Carbon Resistor	6 B	4 D
R850	10Ω ½W ±10% Noiseless Carbon Resistor	6 D	2 D
R851	0.5Ω 2 W ±10% Wirewound Resistor	6 B	TR-8LB
R852	0.5Ω 2 W ±10% Wirewound Resistor	6 D	TR-8RB
R853	0.5Ω 2 W ±10% Wirewound Resistor	6 B	TR-8LB
R854	0.5Ω 2 W ±10% Wirewound Resistor	6 D	TR-8RB
R855	6.8Ω 3 W ±10% Carbon Fixed Resistor	6 B	TR-8LB
R856	6.8Ω 3 W ±10% Carbon Fixed Resistor	6 D	TR-8RB
R857	}2Ω × 2 20W ±10% Cement Resistor Block {	7 B	2 G
R858		7 D	
R859	470Ω 1 W ±10% Carbon Fixed Resistor	7 B	2 E
R860	470Ω 1 W ±10% Carbon Fixed Resistor	7 B	1 E
R901	2.2kΩ ¼W ±10% Carbon Fixed Resistor	7 C	TR-90A
R902	2.2kΩ ¼W ±10% Carbon Fixed Resistor	7 C	TR-90A
R903	4.7kΩ ¼W ±10% Carbon Fixed Resistor	7 C	TR-90A
R904	10kΩ ¼W ±10% Carbon Fixed Resistor	7 C	TR-90A
R905	10kΩ ¼W ±10% Carbon Fixed Resistor	7 C	TR-90A
R906	330Ω 3 W ±10% Carbon Fixed Resistor	3 E	TR-90A
R907	4.7Ω 1 W ±10% Carbon Fixed Resistor	3 E	TR-90A
R908	6.8kΩ ¼W ±10% Carbon Fixed Resistor R Type	5 D	TR-90A
C001	0.033μF ±10% 600VDC Oil Capacitor	1 E	2 H
C002	4000μF 80VDC Electrolytic Capacitor	3 E	2 F
C003	200μF 50VDC Electrolytic Capacitor	3 E	3 G
C004	1000μF 35VDC Electrolytic Capacitor	4 E	4 B
C005	500μF 35VDC Electrolytic Capacitor	4 E	4 F

A	B	C	D
C006	500μF 50VDC Electrolytic Capacitor	3 E	4 B
C007	200μF 50VDC Electrolytic Capacitor	3 E	3 G
C601	1.5μF 15VDC Tantalum Electrolytic Capacitor	1 B	TRHA-6A
C602	1.5μF 15VDC Electrolytic Capacitor	1 B	TRHA-6A
C603	150 pF ±10% 50VDC Ceramic Capacitor	1 B	TRHA-6B
C604	150 pF ±10% 50VDC Ceramic Capacitor	1 D	TRHA-6B
C605	30μF 10VDC Electrolytic Capacitor	1 B	TRHA-6B
C606	30μF 10VDC Electrolytic Capacitor	1 D	TRHA-6B
C607	10μF 30VDC Electrolytic Capacitor	1 B	TRHA-6B
C608	10μF 30VDC Electrolytic Capacitor	1 D	TRHA-6B
C609	150 pF ±10% 50VDC Ceramic Capacitor	1 A	TRHA-6B
C610	150 pF ±10% 50VDC Ceramic Capacitor	1 C	TRHA-6B
C611	10μF 25VDC Electrolytic Capacitor	1 A	TRHA-6B
C612	10μF 25VDC Electrolytic Capacitor	1 C	TRHA-6B
C613	50μF 6VDC Electrolytic Capacitor	1 B	TRHA-6B
C614	50μF 6VDC Electrolytic Capacitor	1 D	TRHA-6B
C615	0.004μF ±10% 50VDC Mylar Capacitor	1 B	TRHA-6B
C616	0.004μF ±10% 50VDC Mylar Capacitor	1 D	TRHA-6B
C617	0.01μF ±10% 50VDC Mylar Capacitor	1 B	TRHA-6B
C618	0.01μF ±10% 50VDC Mylar Capacitor	1 D	TRHA-6B
C619	0.003μF ±10% 50VDC Mylar Capacitor	1 B	TRHA-6B
C620	0.003μF ±10% 50VDC Mylar Capacitor	1 D	TRHA-6B
C621	10μF 10VDC Electrolytic Capacitor	1 A	TRHA-6B
C622	10μF 10VDC Electrolytic Capacitor	1 C	TRHA-6B
C623	0.05μF ±10% 50VDC Mylar Capacitor	1 B	TRHA-6B
C624	0.05μF ±10% 50VDC Mylar Capacitor	1 D	TRHA-6B
C701	200 pF ±10% 500VDC Mica Capacitor	2 B	5 E
C702	200 pF ±10% 500VDC Mica Capacitor	2 D	5 E
C703	0.01μF ±10% 50VDC Mylar Capacitor	2 B	5 E
C704	0.01μF ±10% 50VDC Mylar Capacitor	2 D	5 E
C705	0.2μF ±10% 50VDC Mylar Capacitor	2 B	TR-70A
C706	0.2μF ±10% 50VDC Mylar Capacitor	2 D	TR-70A
C707	0.02μF ±10% 50VDC Mylar Capacitor	2 A	5 A
C708	0.02μF ±10% 50VDC Mylar Capacitor	2 C	3 A
C709	0.015μF ±10% 50VDC Mylar Capacitor	2 A	5 A
C710	0.015μF ±10% 50VDC Mylar Capacitor	2 C	3 A
C711	0.01μF ±10% 50VDC Mylar Capacitor	2 A	5 A
C712	0.01μF ±10% 50VDC Mylar Capacitor	2 C	3 A
C713	0.007μF ±10% 50VDC Mylar Capacitor	2 A	5 A
C714	0.007μF ±10% 50VDC Mylar Capacitor	2 C	3 A
C715	0.003μF ±10% 50VDC Mylar Capacitor	2 A	5 A
C716	0.003μF ±10% 50VDC Mylar Capacitor	2 C	3 A
C717	500 pF ±10% 500VDC Mica Capacitor	2 A	5 A
C718	500 pF ±10% 500VDC Mica Capacitor	2 C	3 A
C719	0.001μF ±10% 50VDC Mylar Capacitor	2 B	5 A
C720	0.001μF ±10% 50VDC Mylar Capacitor	2 D	3 A
C721	0.002μF ±10% 50VDC Mylar Capacitor	2 B	5 A
C722	0.002μF ±10% 50VDC Mylar Capacitor	2 D	3 A
C723	0.003μF ±10% 50VDC Mylar Capacitor	2 B	5 A

A	B	C	D
C724	0.003 μ F \pm 10% 50VDC Mylar Capacitor	2 D	3 A
C725	0.004 μ F \pm 10% 50VDC Mylar Capacitor	2 B	5 A
C726	0.004 μ F \pm 10% 50VDC Mylar Capacitor	2 D	3 A
C727	10 μ F 10VDC Electrolytic Capacitor	2 B	5 A
C728	10 μ F 10VDC Electrolytic Capacitor	2 D	3 A
C729	300 pF \pm 10% 505VDC Mica Capacitor	2 B	TR-70A
C730	300 pF \pm 10% 505VDC Mica Capacitor	2 D	TR-70A
C731	0.03 μ F \pm 10% 50VDC Mylar Capacitor	2 A	2 E
C732	0.03 μ F \pm 10% 50VDC Mylar Capacitor	2 C	4 E
C733	0.03 μ F \pm 10% 50VDC Mylar Capacitor	3 B	2 E
C734	0.03 μ F \pm 10% 50VDC Mylar Capacitor	3 D	4 E
C735	10 μ F 10VDC Electrolytic Capacitor	2 B	TR-70A
C736	10 μ F 10VDC Electrolytic Capacitor	2 D	TR-70A
C737	10 μ F 10VDC Electrolytic Capacitor	2 B	TR-70A
C738	10 μ F 10VDC Electrolytic Capacitor	2 D	TR-70A
C739	50 μ F 6VDC Electrolytic Capacitor	2 B	TR-70A
C740	50 μ F 6VDC Electrolytic Capacitor	2 D	TR-70A
C741	10 μ F 10VDC Electrolytic Capacitor	3 B	TR-70A
C742	10 μ F 10VDC Electrolytic Capacitor	3 D	TR-70A
C743	0.001 μ F \pm 10% 50VDC Mylar Capacitor	3 B	TR-70A
C744	0.001 μ F \pm 10% 50VDC Mylar Capacitor	3 D	TR-70A
C745	0.01 μ F \pm 10% 50VDC Mylar Capacitor	3 A	2 E
C746	0.01 μ F \pm 10% 50VDC Mylar Capacitor	3 C	4 E
C747	0.02 μ F \pm 10% 50VDC Mylar Capacitor	3 A	2 E
C748	0.02 μ F \pm 10% 50VDC Mylar Capacitor	3 C	4 E
C749	0.03 μ F \pm 10% 50VDC Mylar Capacitor	3 A	2 E
C750	0.03 μ F \pm 10% 50VDC Mylar Capacitor	3 C	4 E
C751	0.05 μ F \pm 10% 50VDC Mylar Capacitor	3 A	2 E
C752	0.05 μ F \pm 10% 50VDC Mylar Capacitor	3 C	4 E
C753	0.05 μ F \pm 10% 50VDC Mylar Capacitor	3 B	2 E
C754	0.05 μ F \pm 10% 50VDC Mylar Capacitor	3 D	4 E
C755	0.03 μ F \pm 10% 50VDC Mylar Capacitor	3 B	2 E
C756	0.03 μ F \pm 10% 50VDC Mylar Capacitor	3 D	4 E
C757	0.02 μ F \pm 10% 50VDC Mylar Capacitor	3 B	2 E
C758	0.02 μ F \pm 10% 50VDC Mylar Capacitor	3 D	4 E
C759	0.01 μ F \pm 10% 50VDC Mylar Capacitor	3 B	2 E
C760	0.01 μ F \pm 10% 50VDC Mylar Capacitor	3 D	4 E
C761	10 pF \pm 10% 500VDC Mica Capacitor	3 B	TR-70A
C762	10 pF \pm 10% 500VDC Mica Capacitor	3 D	TR-70A
C763	0.2 μ F \pm 10% 50VDC Mylar Capacitor	3 B	TR-70A
C764	0.2 μ F \pm 10% 50VDC Mylar Capacitor	3 D	TR-70A
C765	0.02 μ F \pm 10% 50VDC Mylar Capacitor	3 B	TR-70A
C766	0.02 μ F \pm 10% 50VDC Mylar Capacitor	3 D	TR-70A
C767	0.02 μ F \pm 10% 50VDC Mylar Capacitor	3 B	TR-70A
C768	0.02 μ F \pm 10% 50VDC Mylar Capacitor	3 D	TR-70A
C769	0.5 μ F \pm 10% 50VDC Mylar Capacitor	3 B	TR-70A
C770	0.5 μ F \pm 10% 50VDC Mylar Capacitor	3 D	TR-70A
C771	10 μ F 25VDC Electrolytic Capacitor	3 B	TR-70A
C772	10 μ F 25VDC Electrolytic Capacitor	3 D	TR-70A

A	B	C	D
C773	0.5 μ F \pm 10% 50VDC Mylar Capacitor	3 B	TR-70A
C774	0.5 μ F \pm 10% 50VDC Mylar Capacitor	3 D	TR-70A
C775	50 μ F 6VDC Electrolytic Capacitor	3 B	TR-70A
C776	50 μ F 6VDC Electrolytic Capacitor	3 D	TR-70A
C777	0.1 μ F \pm 10% 50VDC Mylar Capacitor	4 B	TR-70A
C778	0.1 μ F \pm 10% 50VDC Mylar Capacitor	4 D	TR-70A
C779	0.001 μ F \pm 10% 50VDC Mylar Capacitor	4 B	TR-70A
C780	0.001 μ F \pm 10% 50VDC Mylar Capacitor	4 D	TR-70A
C781	0.001 μ F \pm 10% 50VDC Mylar Capacitor	4 B	TR-70A
C782	0.001 μ F \pm 10% 50VDC Mylar Capacitor	4 D	TR-70A
C783	10 μ F 10VDC Electrolytic Capacitor	4 B	TR-70A
C784	10 μ F 10VDC Electrolytic Capacitor	4 D	TR-70A
C785	0.003 μ F \pm 10% 50VDC Mylar Capacitor	4 B	TR-70A
C786	0.003 μ F \pm 10% 50VDC Mylar Capacitor	4 D	TR-70A
C787	10 μ F 10VDC Electrolytic Capacitor	4 B	TR-70A
C788	10 μ F 10VDC Electrolytic Capacitor	4 D	TR-70A
C789	10 μ F 25VDC Electrolytic Capacitor	4 B	TR-70A
C790	10 μ F 25VDC Electrolytic Capacitor	4 D	TR-70A
C801	10 μ F 10VDC Electrolytic Capacitor	5 B	TR-80A
C802	10 μ F 10VDC Electrolytic Capacitor	5 D	TR-80A
C803	300 pF \pm 10% 500VDC Mica Capacitor	5 B	TR-80A
C804	300 pF \pm 10% 500VDC Mica Capacitor	5 D	TR-80A
C805	10 μ F 25VDC Electrolytic Capacitor	5 B	TR-80A
C806	10 μ F 25VDC Electrolytic Capacitor	5 D	TR-80A
C807	3.3 μ F 15VDC Electrolytic Capacitor	5 B	TR-80A
C808	3.3 μ F 15VDC Electrolytic Capacitor	5 D	TR-80A
C809	25 μ F 50VDC Electrolytic Capacitor	5 B	TR-80A
C810	25 μ F 50VDC Electrolytic Capacitor	5 D	TR-80A
C811	500 μ F 6VDC Electrolytic Capacitor	5 B	TR-80A
C812	500 μ F 6VDC Electrolytic Capacitor	5 D	TR-80A
C813	50 μ F 50VDC Electrolytic Capacitor	6 B	TR-80A
C814	50 μ F 50VDC Electrolytic Capacitor	6 D	TR-80A
C815	200 μ F 6VDC Electrolytic Capacitor	6 B	TR-80A
C816	200 μ F 6VDC Electrolytic Capacitor	6 D	TR-80A
C817	500 μ F 35VDC Electrolytic Capacitor	6 B	4 H
C818	500 μ F 35VDC Electrolytic Capacitor	6 D	5 H
C819	2000 μ F 35VDC Electrolytic Capacitor	6 B	4 B
C820	2000 μ F 35VDC Electrolytic Capacitor	6 D	4 B
C821	100 μ F 25VDC Electrolytic Capacitor	6 B	TR-80A
C822	100 μ F 25VDC Electrolytic Capacitor	6 D	TR-80A
C823	5 μ F 15VDC Electrolytic Capacitor	6 A	TR-80A
C824	5 μ F 15VDC Electrolytic Capacitor	6 C	TR-80A
C825	1000 μ F 63VDC Electrolytic Capacitor	6 B	4 C
C826	1000 μ F 63VDC Electrolytic Capacitor	6 D	4 C
C827	0.05 μ F \pm 10% 50VDC Mylar Capacitor	6 B	TR-8LB
C828	0.05 μ F \pm 10% 50VDC Mylar Capacitor	6 D	TR-8RB
C829	0.01 μ F \pm 100% 250VDC Ceramic Capacitor	7 A	TR-8LB
C830	0.01 μ F \pm 100% 250VDC Ceramic Capacitor	6 C	TR-8RB
C831	500 μ F 6VDC Electrolytic Capacitor	6 A	TR-80A

PARTS LIST

- A:** Parts No.
B: Parts Name
C: Position of Part (Co-ordinate number and letter in Schematic Diagram)
D: Position of Part (Co-ordinate number and letter on Parts layout or name of Printed Circuit)

A	B	C	D
C832	500 μ F 6VDC Electrolytic Capacitor	6 C	TR-80A
C901	0.05 μ F \pm 10% 50VDC Mylar Capacitor	7 C	TR-90A
C902	0.03 μ F \pm 10% 50VDC Mylar Capacitor	7 C	TR-90A
VR701	}250 k Ω (AC) Balance Control	2 B	2 A
VR702			
VR703	}250 k Ω (B) Master Volume	2 B	3 A
VR704			
VR801	50 k Ω (B) AC Balance Control	5 B	TR-80A
VR802	50 k Ω (B) AC Balance Control	5 D	TR-80A
VR803	200 Ω (B) DC Balance Control	6 B	TR-8LB
VR804	200 Ω (B) DC Balance Control	6 D	TR-8RB
VR901	5 k Ω (B) Power Transistor Protector Circuit	4 E	TR-90A
TR601	2SC650 Si N-P-N Epitaxial Transistor	1 B	TRHA-6A
TR602	2SC650 Si N-P-N Epitaxial Transistor	1 D	TRHA-6A
TR603	2SC281 Si N-P-N Epitaxial Transistor	1 B	TRHA-6A
TR604	2SC281 Si N-P-N Epitaxial Transistor	1 D	TRHA-6A
TR701	2SC650 Si N-P-N Epitaxial Transistor	2 B	TR-70A
TR702	2SC650 Si N-P-N Epitaxial Transistor	2 D	TR-70A
TR703	2SC281 Si N-P-N Epitaxial Transistor	2 B	TR-70A
TR704	2SC281 Si N-P-N Epitaxial Transistor	2 D	TR-70A
TR705	2SC650 Si N-P-N Epitaxial Transistor	3 B	TR-70A
TR706	2SC650 Si N-P-N Epitaxial Transistor	3 D	TR-70A
TR707	2SC281 Si N-P-N Epitaxial Transistor	4 B	TR-70A
TR708	2SC281 Si N-P-N Epitaxial Transistor	4 D	TR-70A
TR801	2SC281 Si N-P-N Epitaxial Transistor	5 B	TR-80A
TR802	2SC281 Si N-P-N Epitaxial Transistor	5 D	TR-80A
TR803	2SC283 Si N-P-N Epitaxial Transistor	5 B	TR-80A
TR804	2SC283 Si N-P-N Epitaxial Transistor	5 D	TR-80A
TR805	2SD144 Si N-P-N Planar Transistor	6 B	3 D
TR806	2SD144 Si N-P-N Planar Transistor	6 D	2 D
TR807	2SD143 Si N-P-N Planar Transistor	6 B	5 D
TR808	2SD143 Si N-P-N Planar Transistor	6 D	3 D
TR809	2SD143 Si N-P-N Planar Transistor	6 B	5 D
TR810	2SD143 Si N-P-N Planar Transistor	6 D	2 D
TR811	2SD46 Si N-P-N Mesa Transistor	6 B	6 D
TR812	2SD46 Si N-P-N Mesa Transistor	6 D	3 D
TR813	2SD46 Si N-P-N Mesa Transistor	6 B	4 D
TR814	2SD46 Si N-P-N Mesa Transistor	6 D	1 D
D001	SA-2Z Silicon Diode, Rectifier	3 E	2 F
D002	SA-2Z Silicon Diode, Rectifier	3 E	2 F
D003	SA-2Z Silicon Diode, Rectifier	3 E	2 F
D004	SA-2Z Silicon Diode, Rectifier	3 E	2 F
D901	OA91 Germanium Diode, Overcurrent Detector	4 E	TR-90A
D902	OA91 Germanium Diode, Overcurrent Detector	4 E	TR-90A
D903	SW-05-02 Silicon Diode, Rectifier	3 E	TR-90A

A	B	C	D
D904	SW-05-02 Silicon Diode, Rectifier	3 E	TR-90A
SCR901	2SF-656 Silicon Controlled Rectifier	3 E	TR-90A
TH801	D-22A (22D45T) Thermistor	6 B	TR-8LB
TH802	D-22A (22D45T) Thermistor	6 D	TR-8RB
TH803	D-22A (22D45T) Thermistor	6 B	TR-8LB
TH804	D-22A (22D45T) Thermistor	6 D	TR-8RB
L801	0.8 μ H High-frequency Compensation	6 B	TR-8LB
L802	0.8 μ H High-frequency Compensation	6 D	TR-8RB
L803	0.8 μ H High-frequency Compensation	6 B	TR-8LB
L804	0.8 μ H High-frequency Compensation	6 D	TR-8RB
PL001	Power Indicator Lamp 8V 0.15A	3 E	6 A
PL002	Protector Indicator Lamp 25V 0.09A	3 E	6 A
F001	AGD 2A Quick-acting Fuse	3 E	4 D
F002	AGD 2A Quick-acting Fuse	3 E	4 D
F003	Power Fuse 2A	2 E	6 D
S1(a~f)	Function Switch	{ 1A, 1B 1C, 1D	1 A
S2a	Mode Switch (STEREO-STEREO REV.)	1 C	6 E
S2b	Mode Switch (STEREO-MONO)	2 C	6 E
S3(a~b)	Tape Monitor Switch	2B, 1D	5 E
S4(a~b)	Loudness Switch	2B, 2D	5 E
S5(a~b)	Tone Control Switch (TREBLE)	2A, 2C	5 A, 3 A
S6(a~d)	Tone Control Switch (BASS)	{ 3A, 3B 3C, 3D	4 E, 2 E
S7(a~b)	Low Filter Switch	3B, 3D	3 E
S8(a~b)	Muting Switch	4B, 4D	4 E
S9(a~b)	High Filter Switch	4B, 4D	4 A
S10(a~b)	Presence Switch	6A, 6C	2 E
S11(a~e)	Speaker Switch	7B, 7D	6 A
S12	AC Power Switch	1 E	1 E
CO1, 2	AC Outlets	1E, 2E	6 D, 5 D
PU001	Line Voltage Controller	2 E	6 B

* All rights reserve specifications subject to change without notice.

COLOR CODE

The color code indicates 10 different colors by using figures of 1 to 9. This code agrees with IEC and JIS.

Color	Common to All Parts			Fixed Resistor Allowance (%)	Mica Capacitor				Paper Capacitor		Ceramic Capacity								
	1st Figure	2nd Figure	Multiplier		Grade	Property	Allowance (%)	Rated Voltage (V)	Allowance (%)	Rated Voltage (V)	Grade	Property	Allowance (%)	Rated Voltage (V)					
black	0	0	1	±2	X	A	±20(M)	300	±20(M)	100	Z		±20	250					
brown	1	1	10 ¹		Y	B			±5(J)	200									
red	2	2	10 ²			C	±2(G)		±2(G)	250									
orange	3	3	10 ³		F	D				400									
yellow	4	4	10 ⁴			E			±15(L)	400									
green	5	5	10 ⁵			F	±5(J)		+20 -15(V)	500									
blue	6	6	10 ⁶		Z					+40(X) -15(X)					600	(Y)		+100 -0	500
purple	7	7	10 ⁷																
grey	8	8	10 ⁸																
white	9	9	10 ⁹																
golden			10 ⁻¹				1000												
silver			10 ⁻²								YY YZ								
non-colored				±5															
				±10															
				±20															

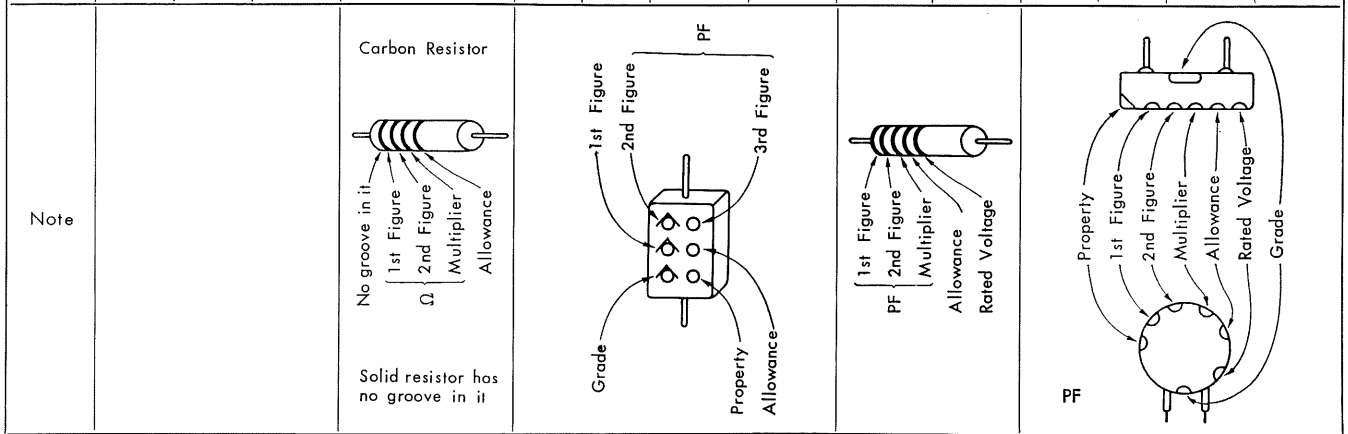

Property	Temperature Coefficient	Divergence of Capacity	Q tanδ	Insulation Resistance	
A	Not specified	Not specified	0.5 under	3000MΩ under	
B	Not specified	Not specified		0.5 over	7500MΩ over but 0.1 over 3000MΩ over
C	-200~+200	±(0.5%+0.5pF)			
D	-100~+100	±(0.3%+0.1pF)			
E	-20~+100	±(0.1%+0.1pF)			
F	0~+70	±(0.05%±0.1pF)			

Grade	Usable Temperature Range	Test Classification
X	-55~+85	I or II
Y	-30~+85	I or II
Z	-30~+85	1

Letter	Allowance
G	±2
J	±5
K	±10
M	±20



Sansui[®]



SANSUI ELECTRIC COMPANY LIMITED



Head Office; 14-1, 2-chome, Izumi, Suginami-ku, Tokyo, Japan. TEL. 323-1111

Printed in Japan (49010M9)